

Оригами алфавит

(автор: Константин Худяков)



Origami Alphabet (cyrillics) by Konstantin Khudyakov
Copyright ©2007. All rights reserved.

Буква "А"

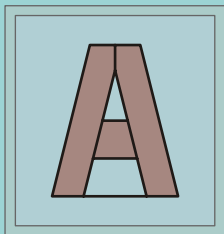

Автор: Константин Худяков
[mailto: konstantin.khudyakov@gmail.com](mailto:konstantin.khudyakov@gmail.com)

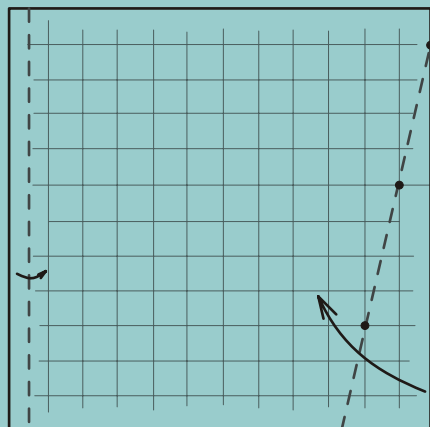

1. 12:12

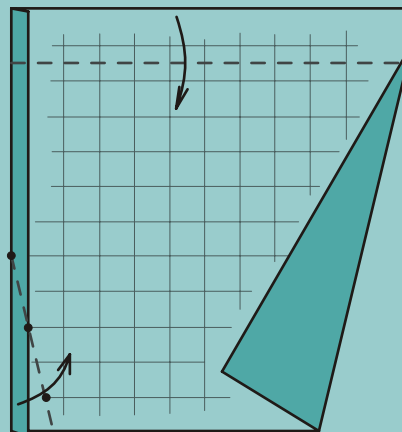

2.

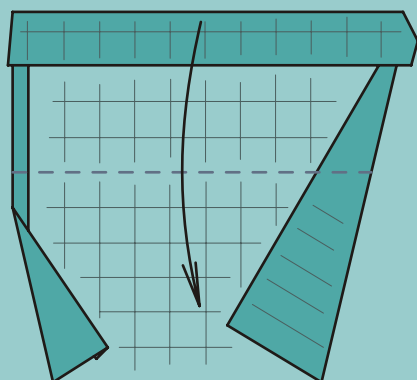

3.

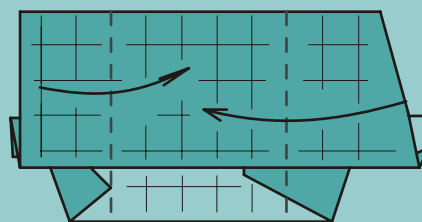

4.

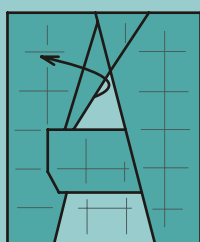

5.

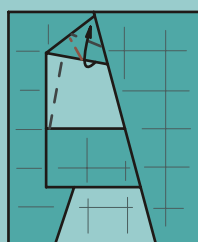

6.

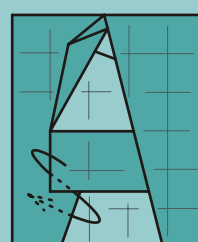

7.

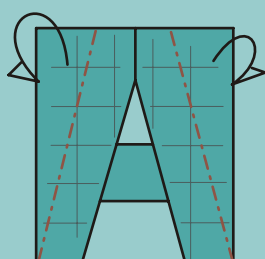

8.



9.

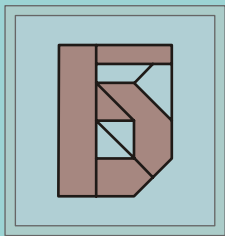

Буква “Б”

2007

Автор: Константин Худяков
mailto: konstantin.khudyakov@gmail.com

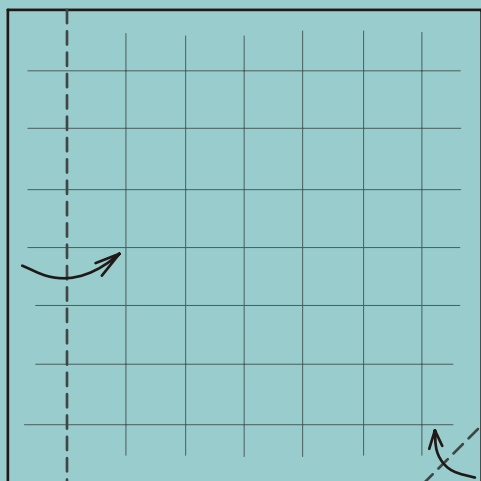

1. 8:8



2.

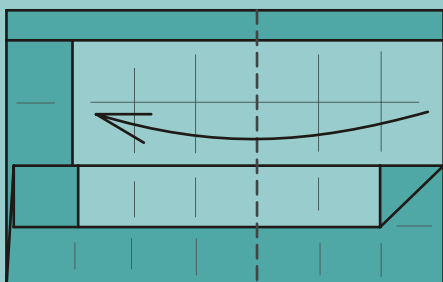

3.

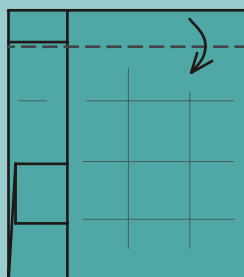

4.

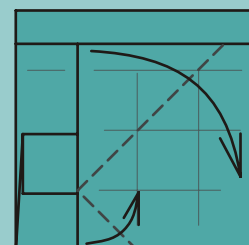

5.

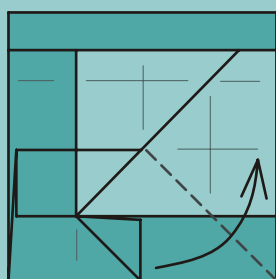

6.

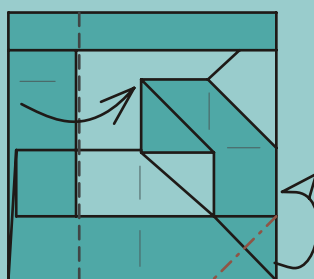

7.

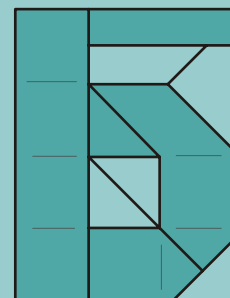

8.

Буква “В”

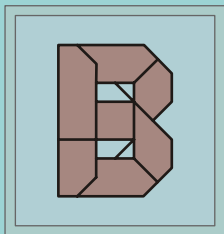

Автор: Константин Худяков
 mailto: konstantin.khudyakov@gmail.com

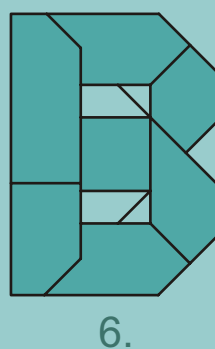
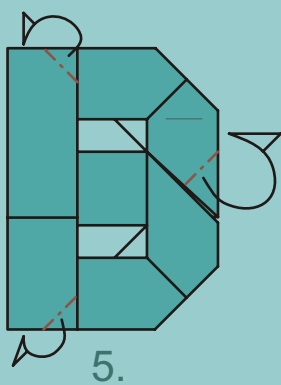
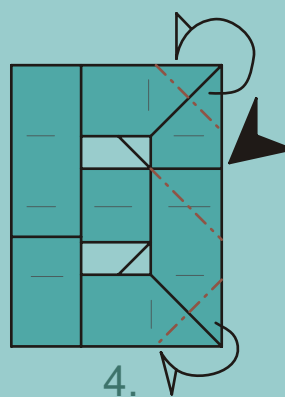
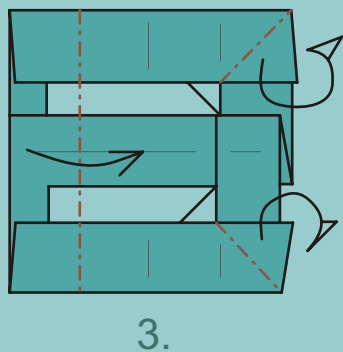
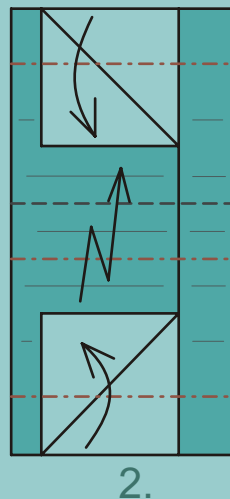
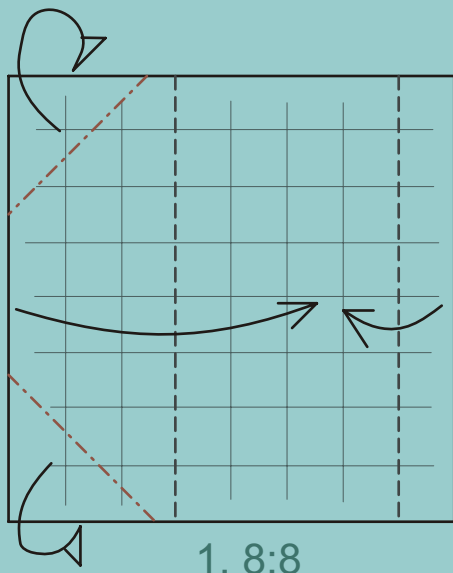

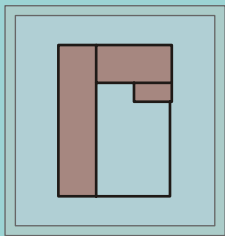

Буква "Г"

2007

Автор: Константин Худяков
mailto:konstantin.khudyakov@gmail.com

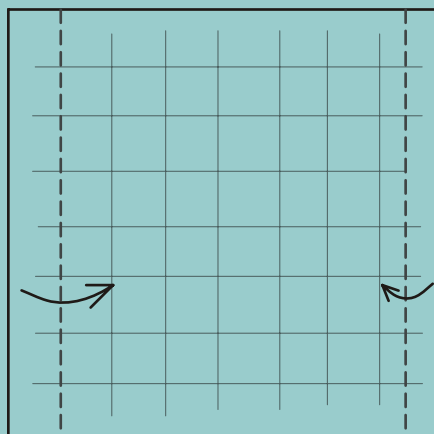

1.

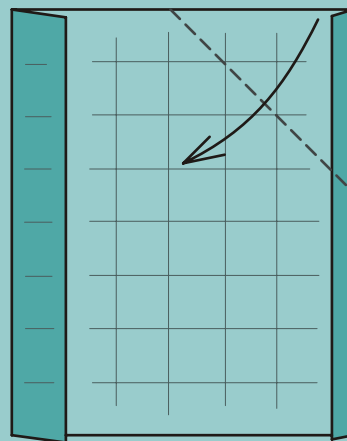

2.

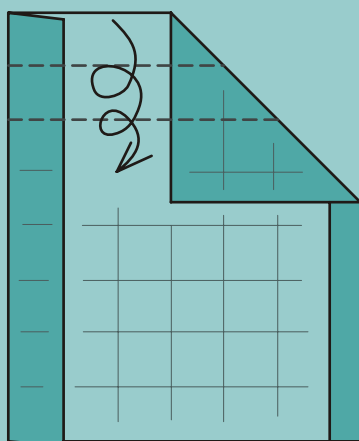

3.

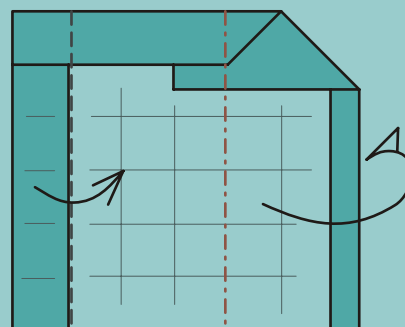

4.

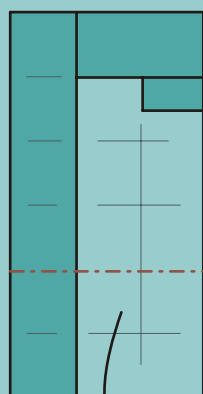

5.

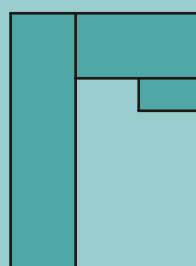

6.

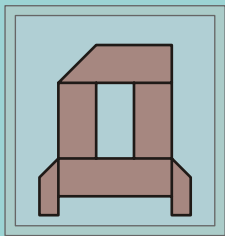

Буква “Д”

2007

Автор: Константин Худяков
[mailto: konstantin.khudyakov@gmail.com](mailto:konstantin.khudyakov@gmail.com)

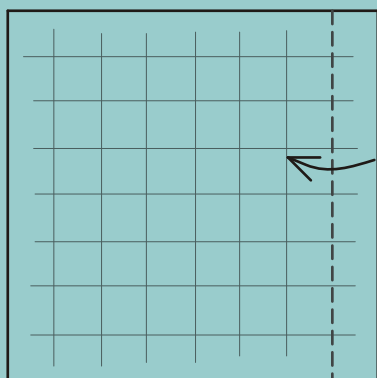

1. 8:8

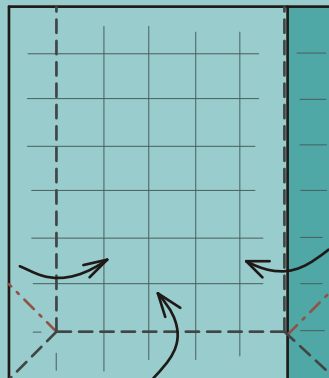

2.

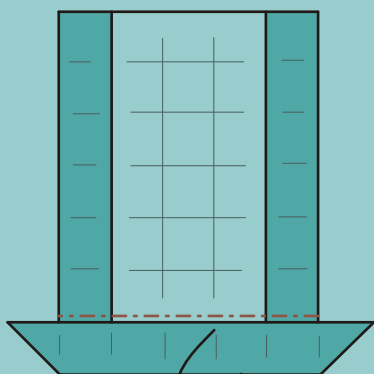

3.

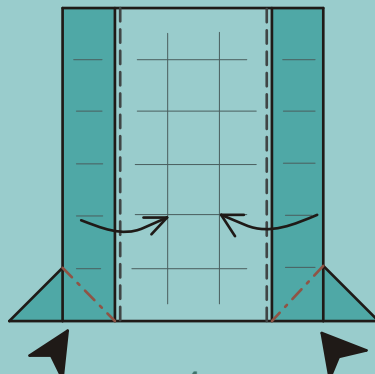

4.

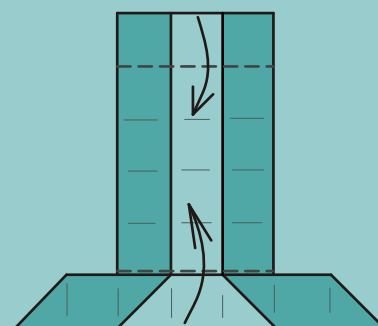

5.

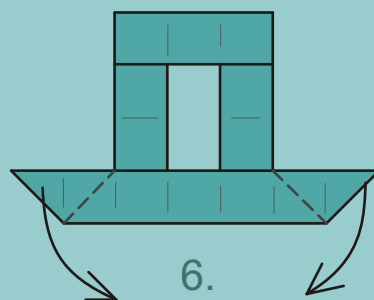

6.

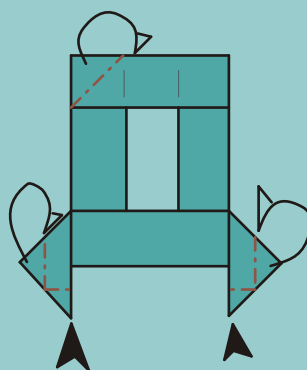

7.

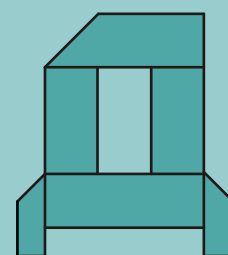

8.

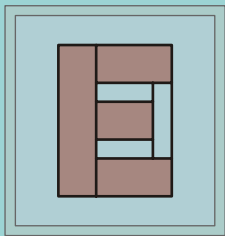

Буква "Е"

2007

Автор: Константин Худяков
mailto:konstantin.khudyakov@gmail.com

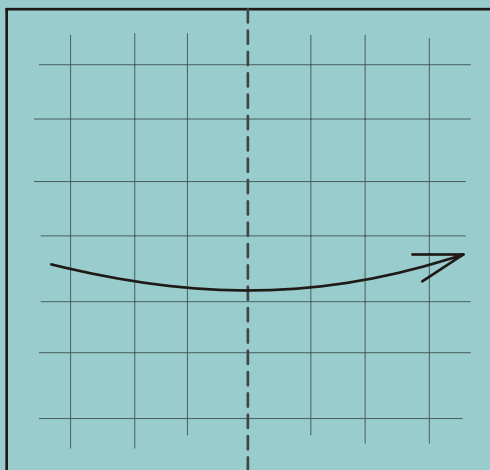

1. 8:8

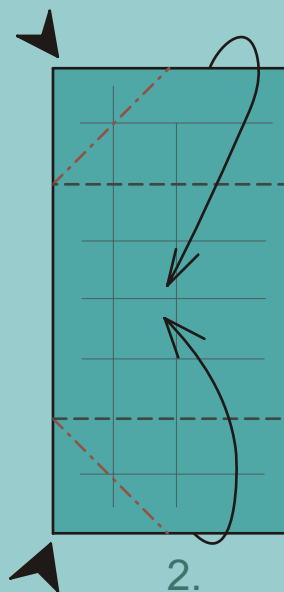

2.

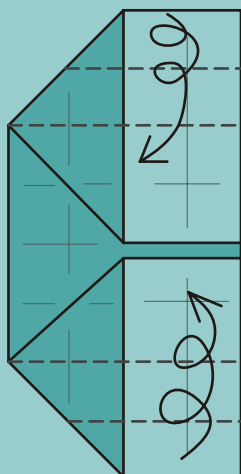

3.

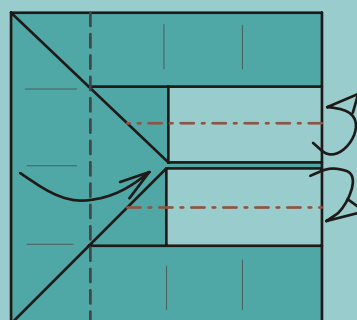

4.

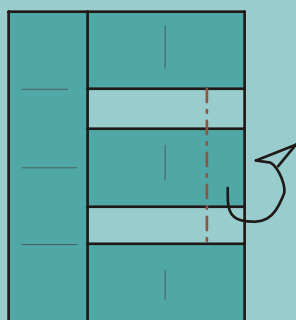

5.

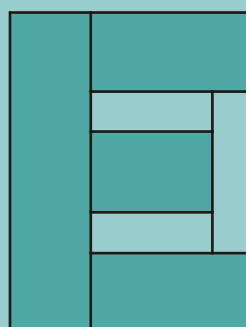

6.

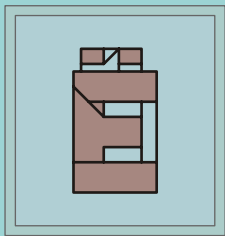

Буква "Ё" #1

2007

Автор: Константин Худяков
mailto:konstantin.khudyakov@gmail.com

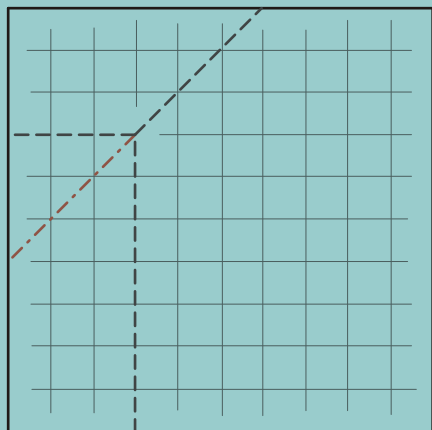

1. 10:10

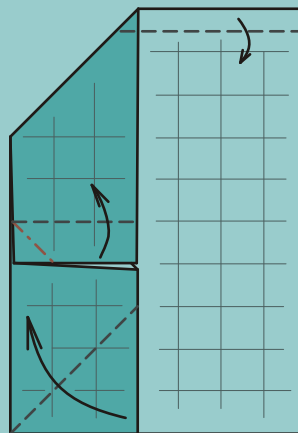

2.

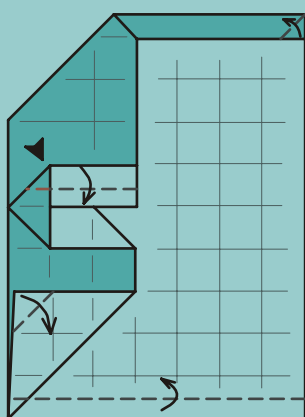

3.

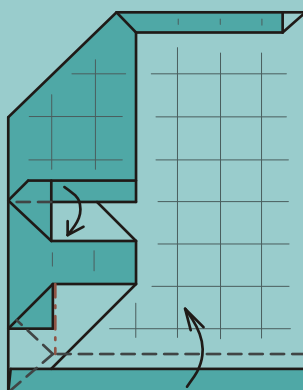

4.

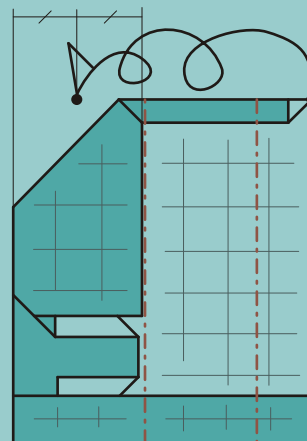

5.

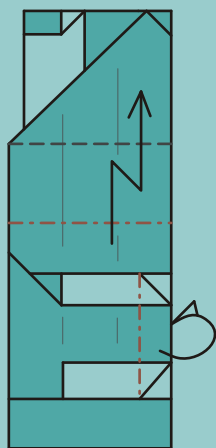

6.

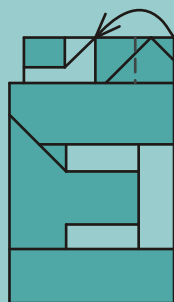

7.

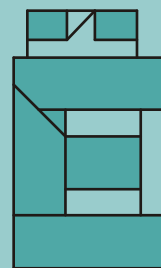

8.

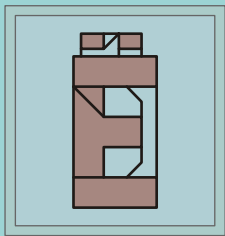

Буква "Ё" #2

2007

Автор: Константин Худяков
mailto: konstantin.khudyakov@gmail.com

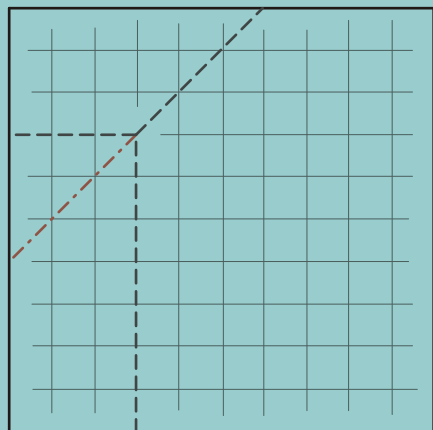

1.

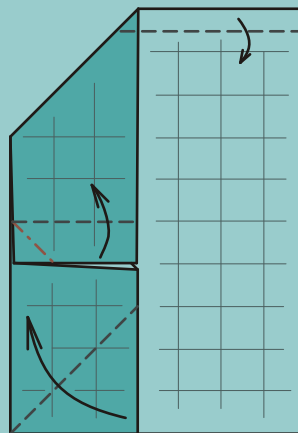

2.

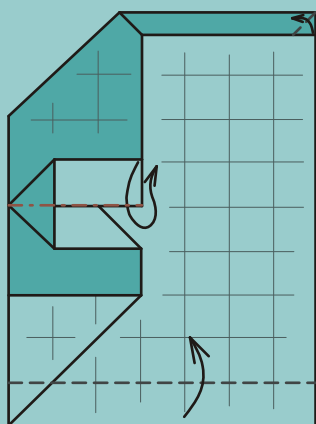

3.

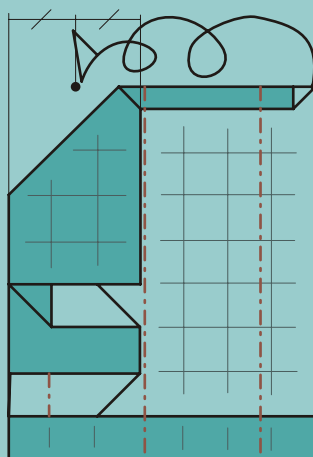

4.

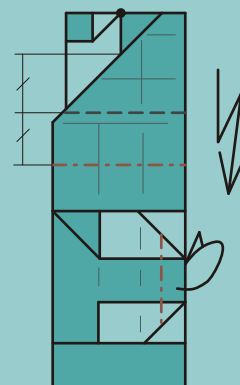

5.

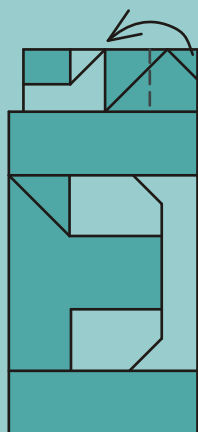

6.

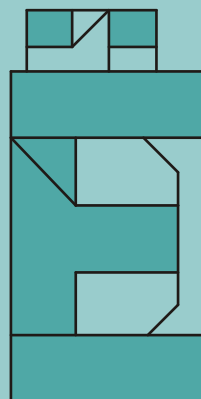

7.

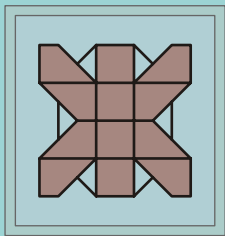

Буква “Ж”

2007

Автор: Константин Худяков
[mailto: konstantin.khudyakov@gmail.com](mailto:konstantin.khudyakov@gmail.com)

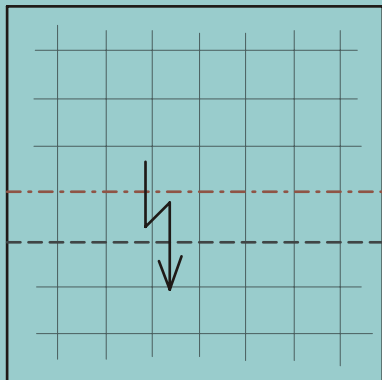

1. 8:8

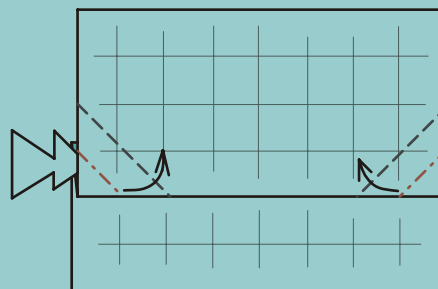

2.

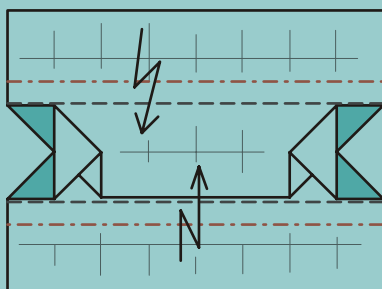

3.

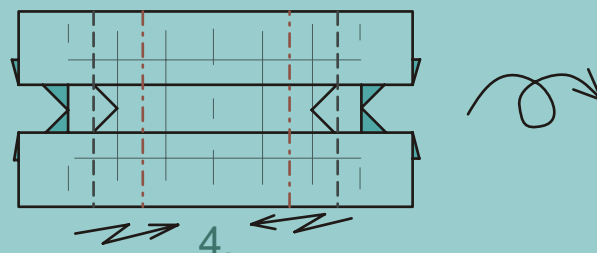

4.

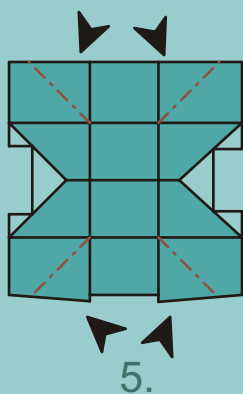

5.

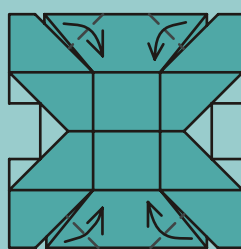

6.

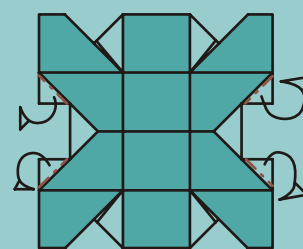

7.

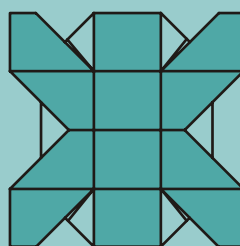

8.

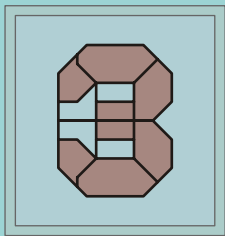

Буква "З"

2007

Автор: Константин Худяков
[mailto: konstantin.khudyakov@gmail.com](mailto:konstantin.khudyakov@gmail.com)

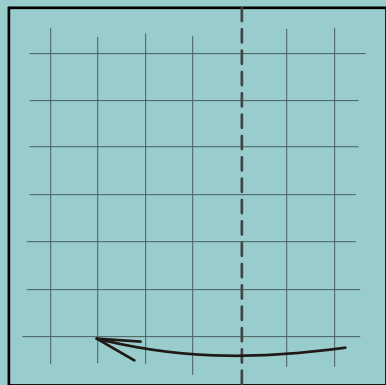

1. 8:8

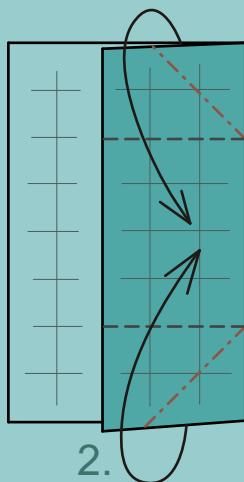

2.

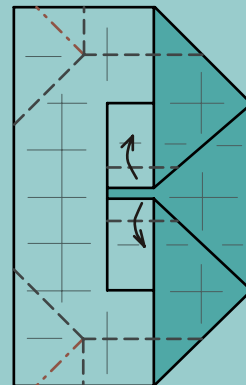

3.

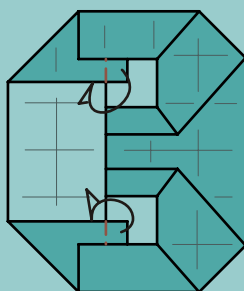

4.

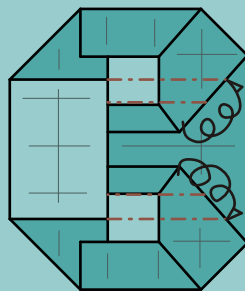

5.

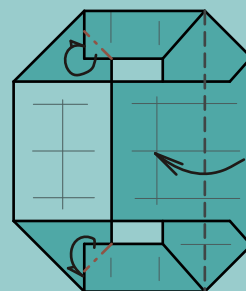

6.

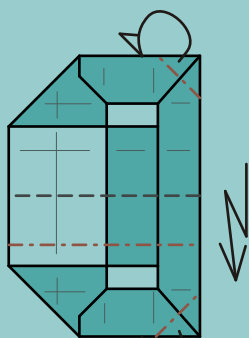

7.

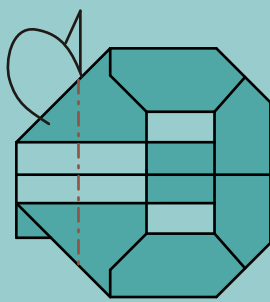

8.

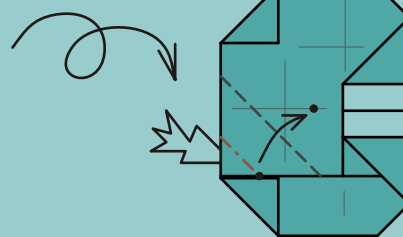

9.

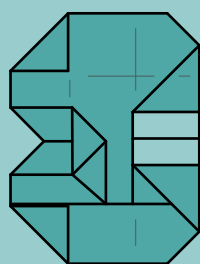

10.

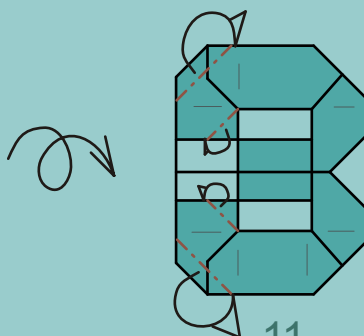

11.

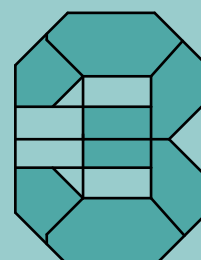

12.

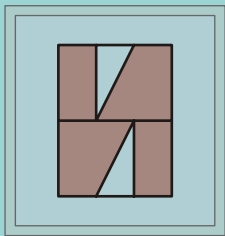

Буква “И”

2007

Автор: Константин Худяков
mailto:konstantin.khudyakov@gmail.com

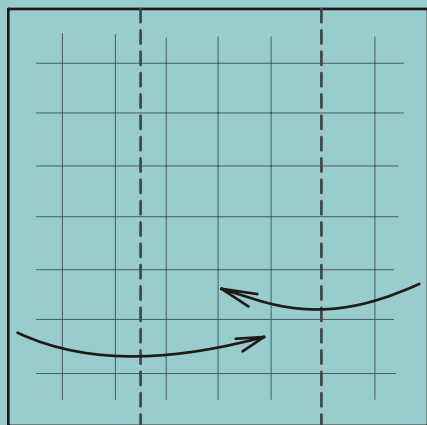

1. 8:8

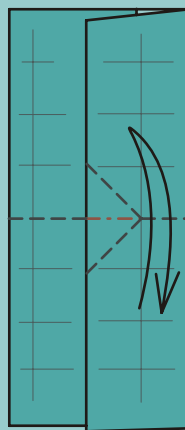

2.

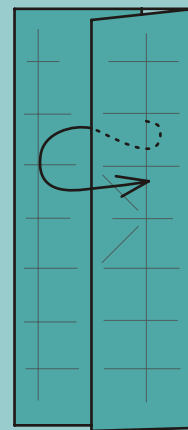

3.

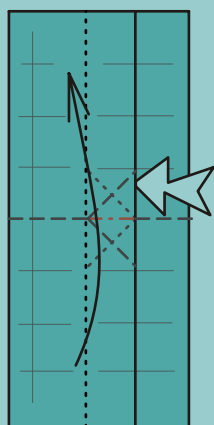

4.

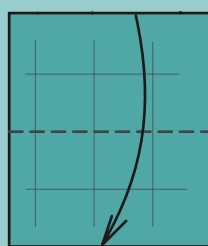

5.

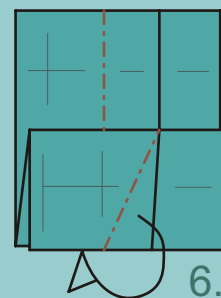

6.

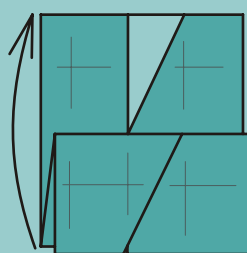

7.

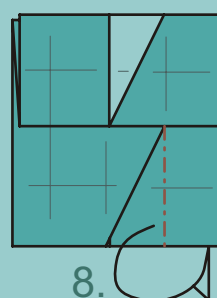

8.

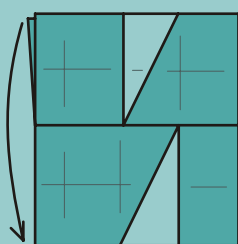

9.

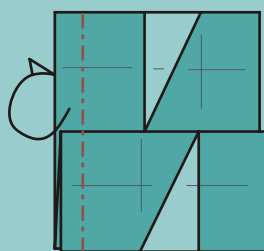

10.

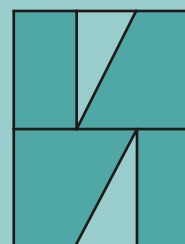

11.

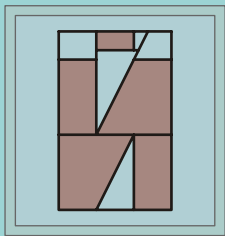

Буква "Й"

2007

Автор: Константин Худяков
[mailto: konstantin.khudyakov@gmail.com](mailto:konstantin.khudyakov@gmail.com)

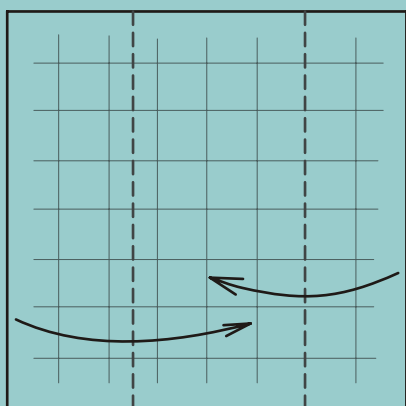

1. 8:8

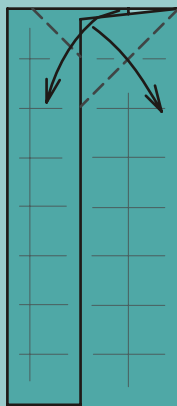

2.

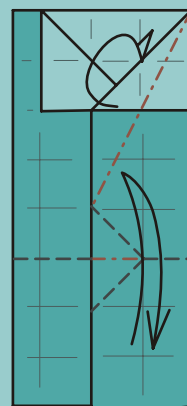

3.

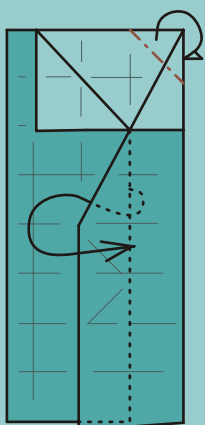

4.

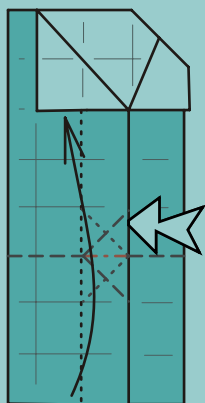

5.

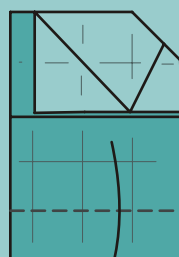

6.

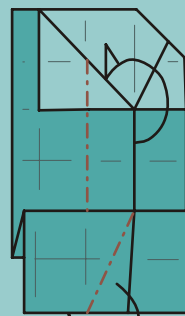

7.

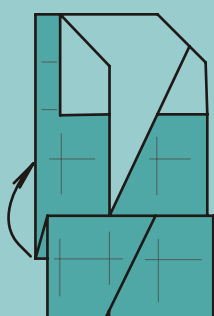

8.

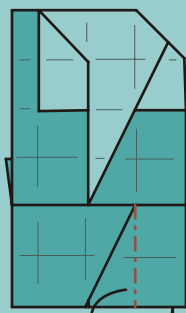

9.

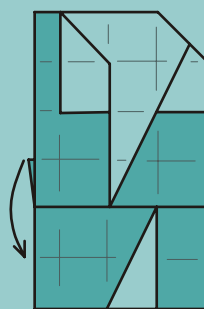

10.

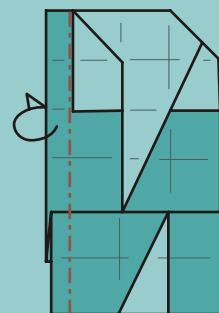

11.

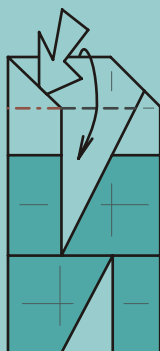

12.

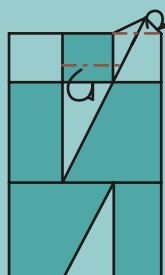

13.

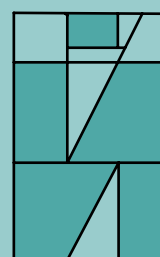

14.

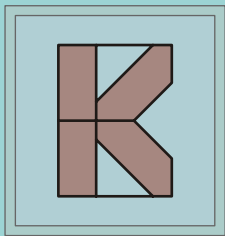

Буква "К"

2007

Автор: Константин Худяков
[mailto: konstantin.khudyakov@gmail.com](mailto:konstantin.khudyakov@gmail.com)

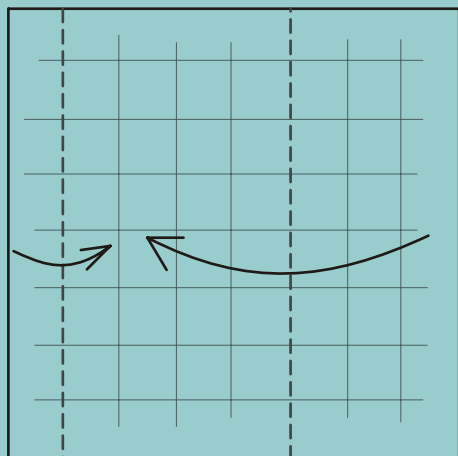

1.

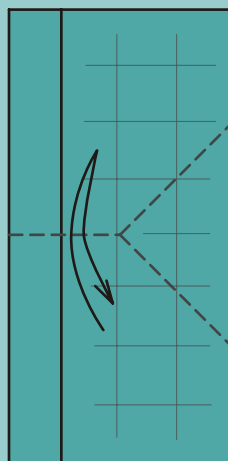

2.

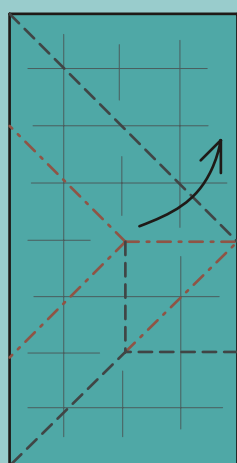

3.

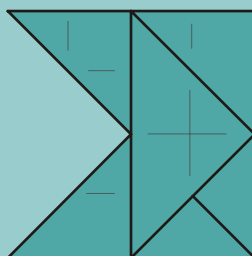

4.

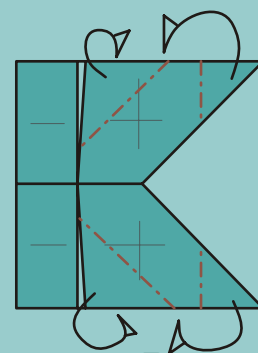

5.

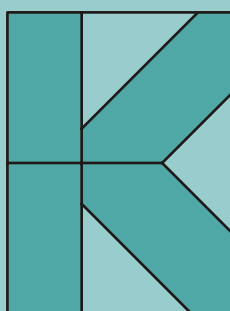

6.

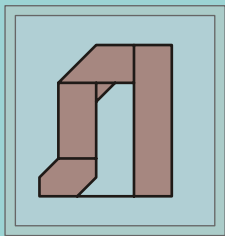

Буква “Л”

2007

Автор: Константин Худяков
[mailto: konstantin.khudyakov@gmail.com](mailto:konstantin.khudyakov@gmail.com)

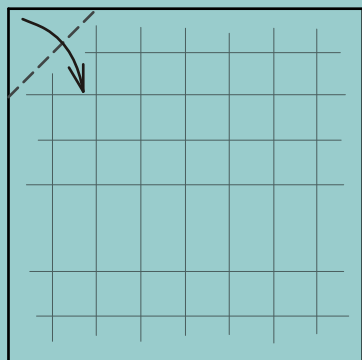

1. 8:8

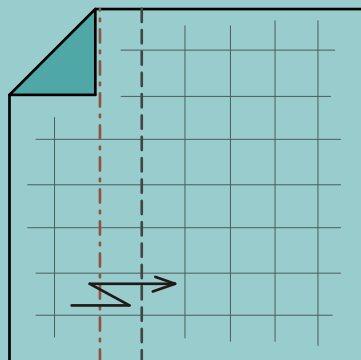

2.

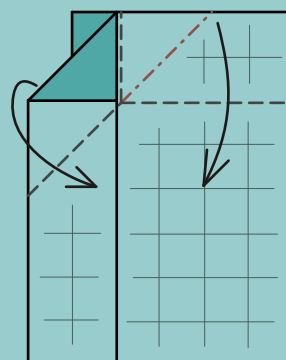

3.

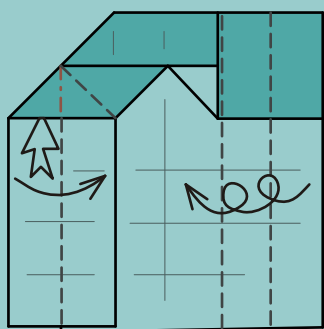

4.

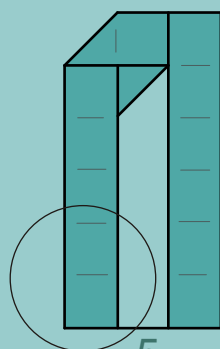

5.



6.

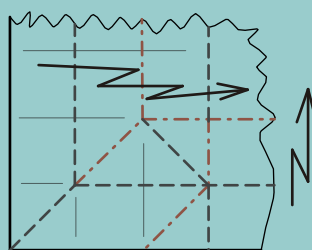

7.

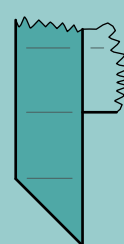

8.

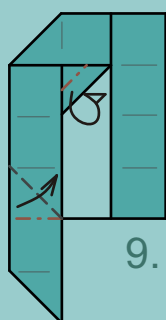

9.

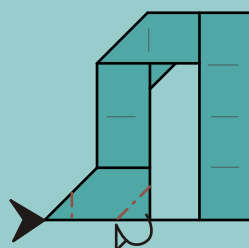

10.



11.

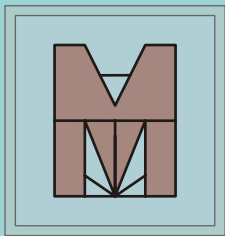

Буква "М"

2007

Автор: Константин Худяков
[mailto: konstantin.khudyakov@gmail.com](mailto:konstantin.khudyakov@gmail.com)

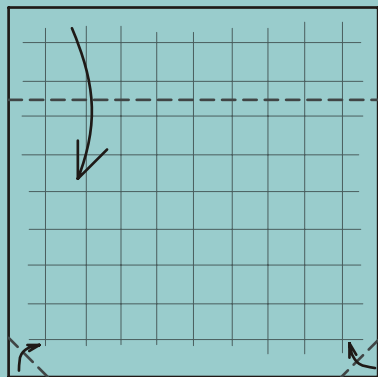

1. 10:10

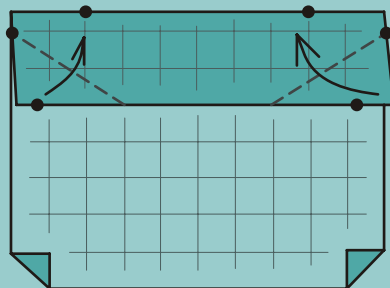

2.

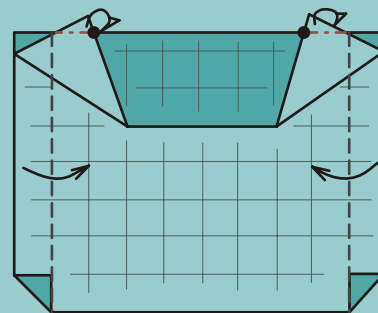

3.

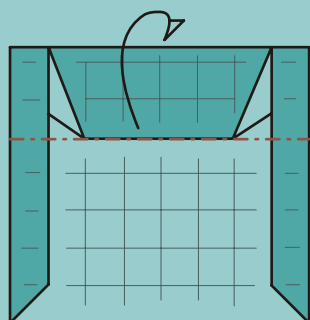

4.

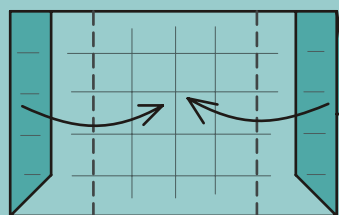

5.

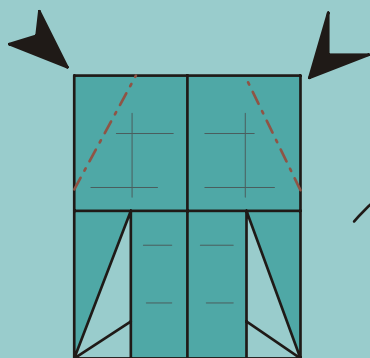

6.

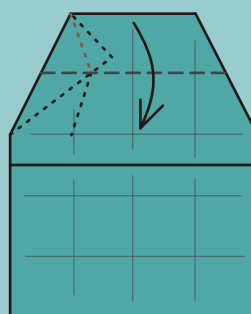

7.

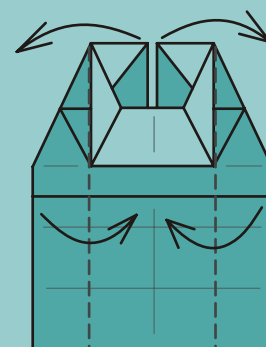

8.

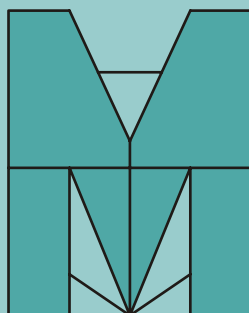

9.

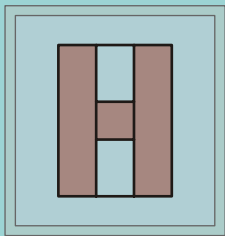

Буква "Н"

2007

Автор: Константин Худяков
[mailto: konstantin.khudyakov@gmail.com](mailto:konstantin.khudyakov@gmail.com)

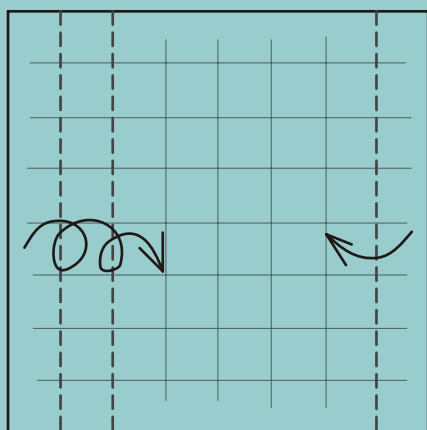

1. 8:8

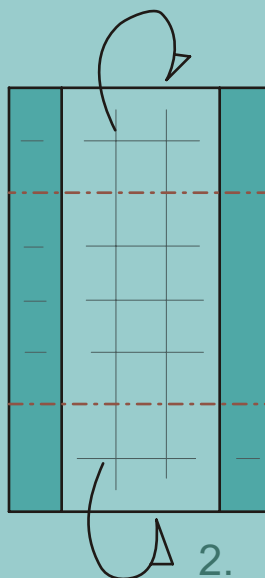

2.

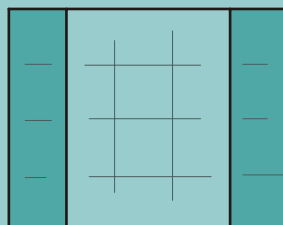

3.

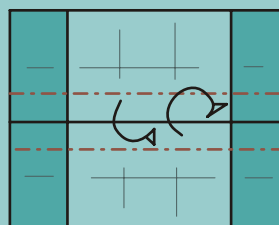

4.

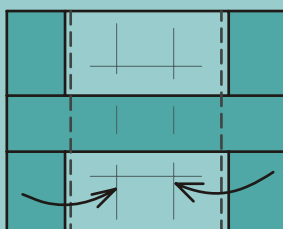

5.

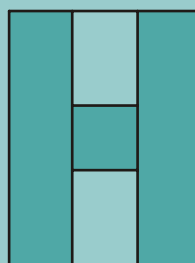

6.

Буква "О"

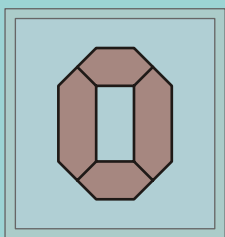

Автор: Константин Худяков
 mailto: konstantin.khudyakov@gmail.com

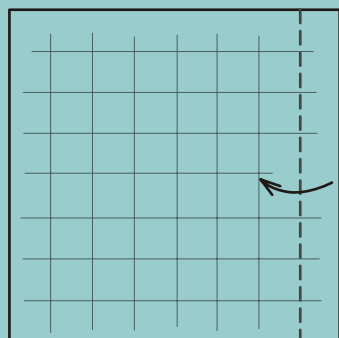

1. 8:8

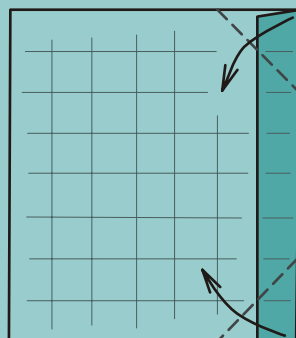

2.

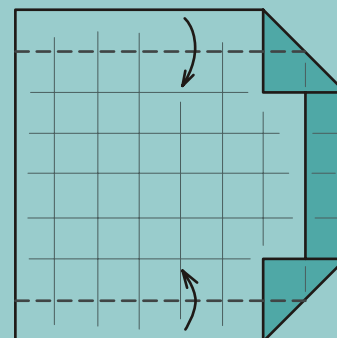

3.

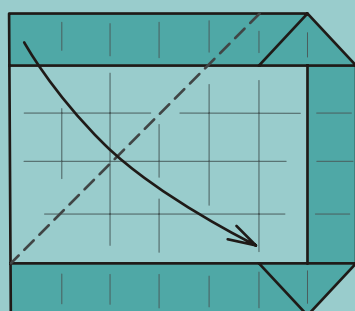

4.

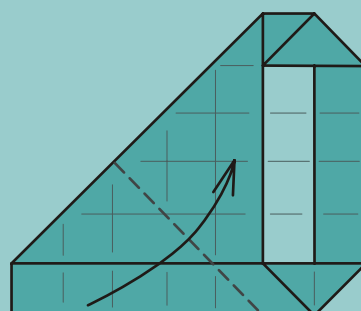

5.

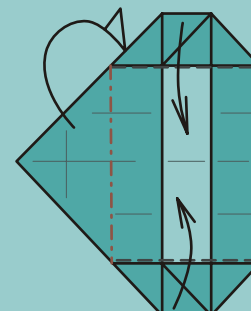

6.

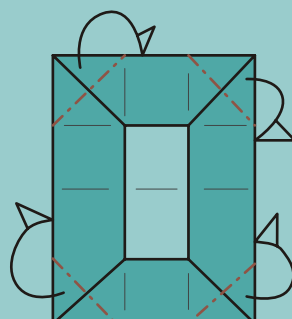

7.

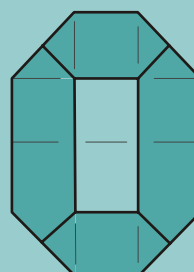

8.

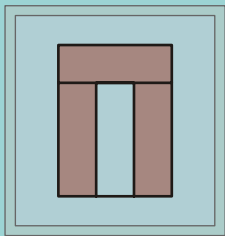

Буква "П"

2007

Автор: Константин Худяков
[mailto: konstantin.khudyakov@gmail.com](mailto:konstantin.khudyakov@gmail.com)

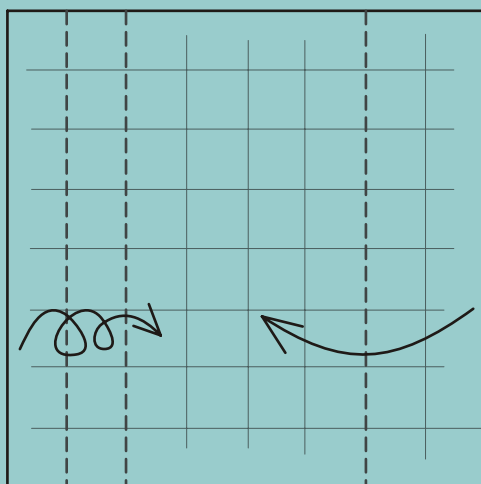

1. 8:8

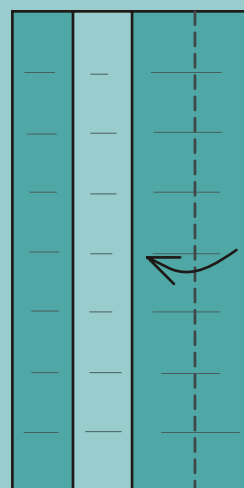

2.

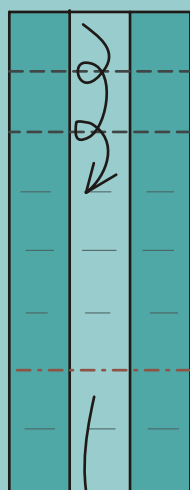

3.

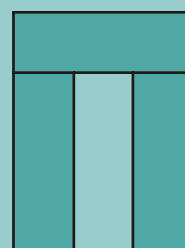

4.

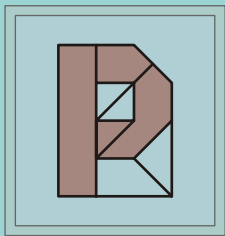

Буквы “Р” и “Ъ”

2007

Автор: Константин Худяков
[mailto: konstantin.khudyakov@gmail.com](mailto:konstantin.khudyakov@gmail.com)

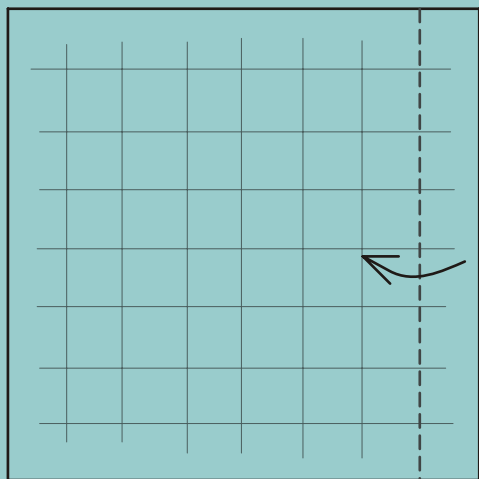

1. 8:8

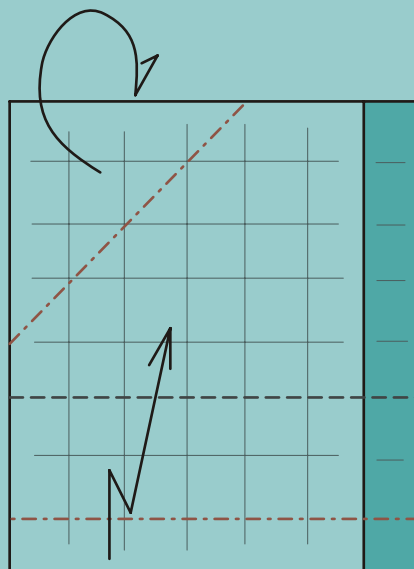

2.

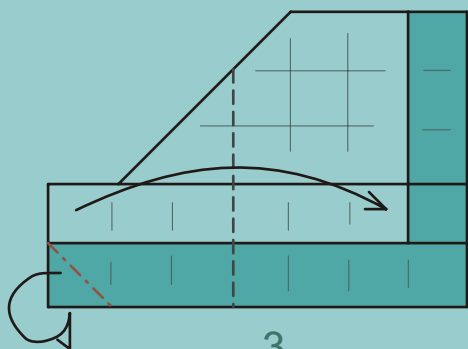

3.

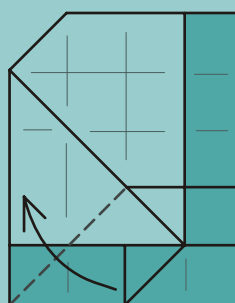

4.

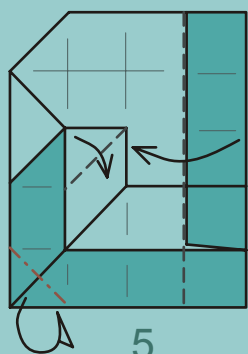

5.

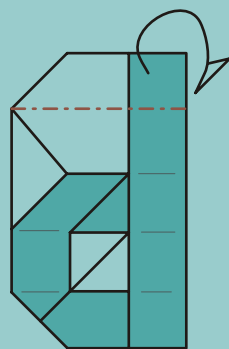

6.

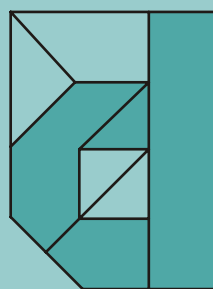

7.



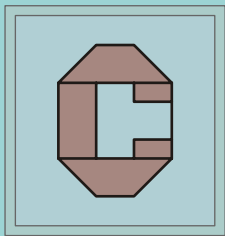

Буква "С"

2007

Автор: Константин Худяков
[mailto: konstantin.khudyakov@gmail.com](mailto:konstantin.khudyakov@gmail.com)

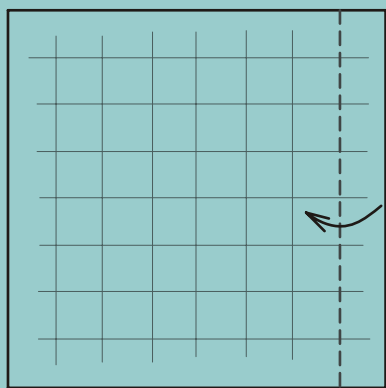

1. 8:8

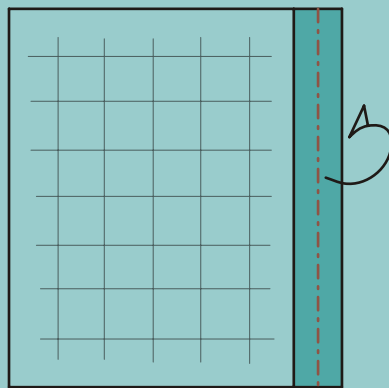

2.

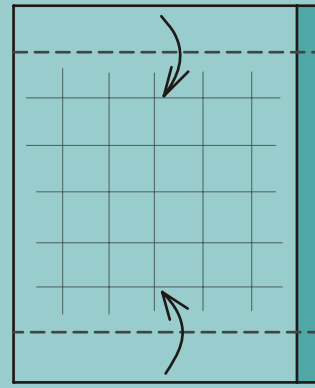

3.

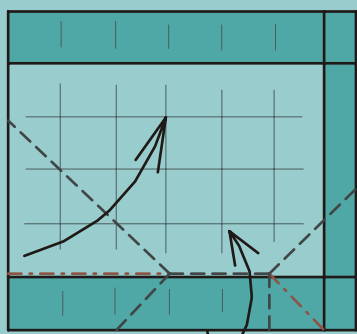

4.

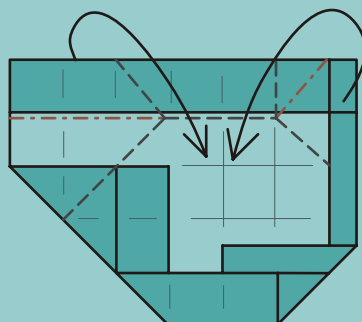

5.

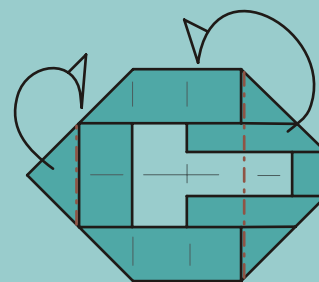

6.

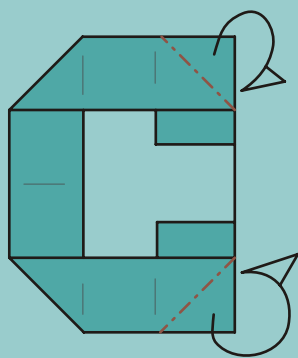

7.

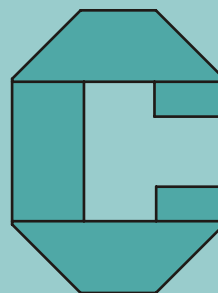

8.

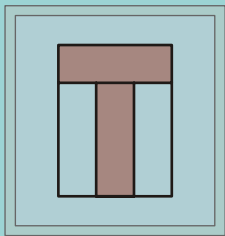

Буква "Т"

2007

Автор: Константин Худяков
[mailto: konstantin.khudyakov@gmail.com](mailto:konstantin.khudyakov@gmail.com)

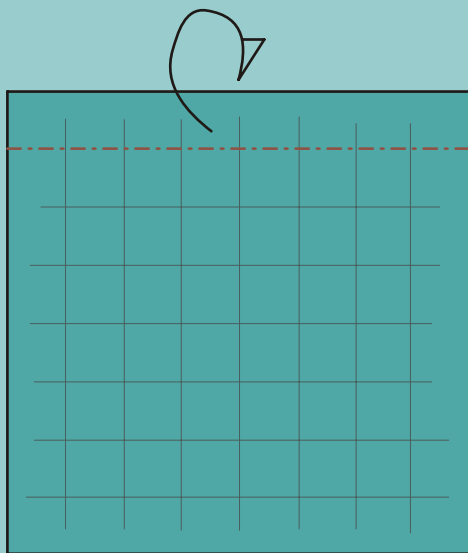

1. 8:8

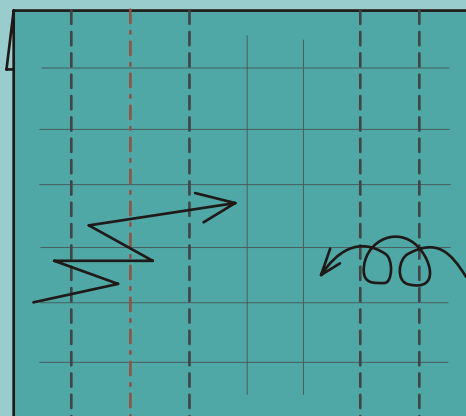

2.

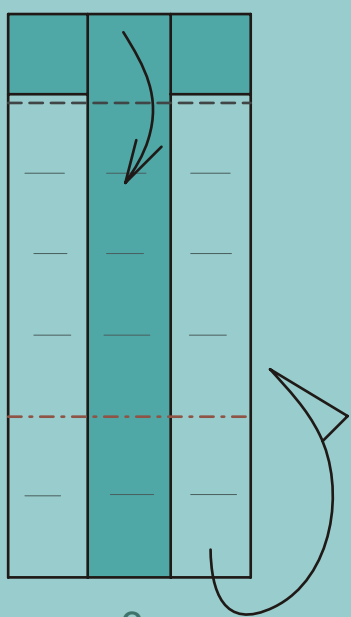

3.

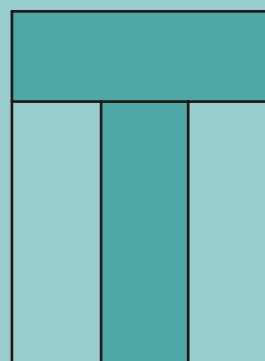

4.

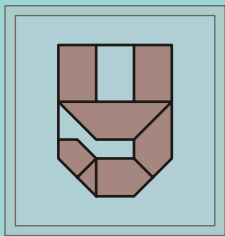

Буква “У”

2007

Автор: Константин Худяков
[mailto: konstantin.khudyakov@gmail.com](mailto:konstantin.khudyakov@gmail.com)

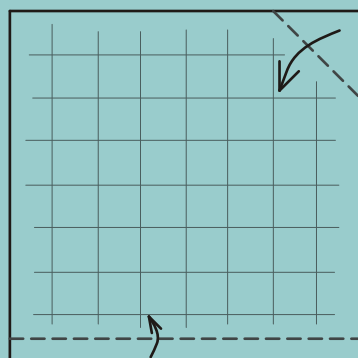

1. 8:8

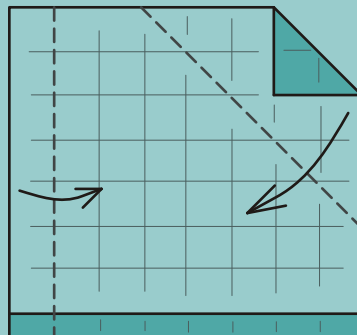

2.

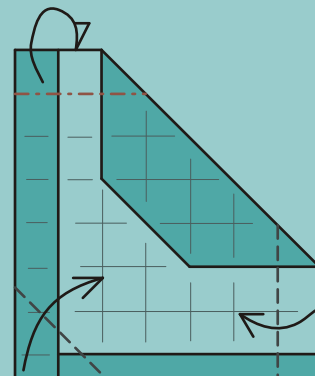

3.

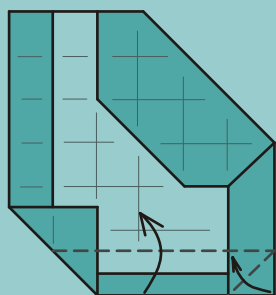

4.

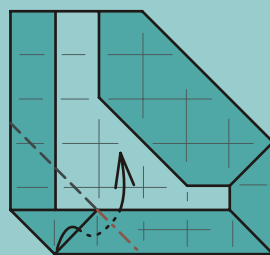

5.

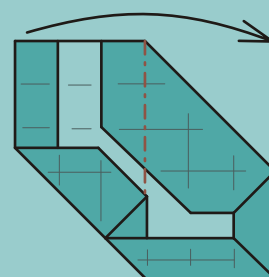

6.

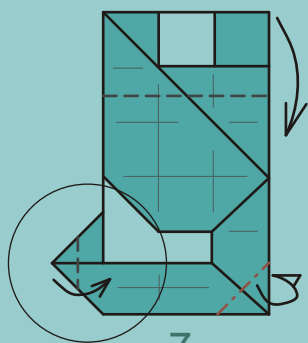

7.

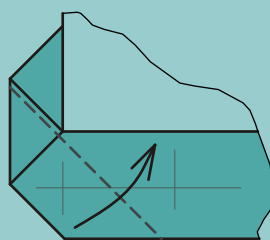

8.

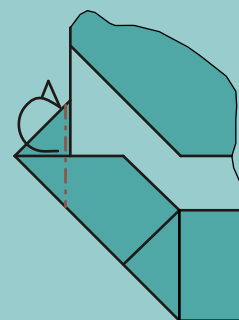

9.

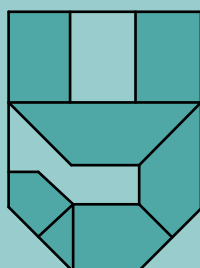

10.

Буква “Ф”

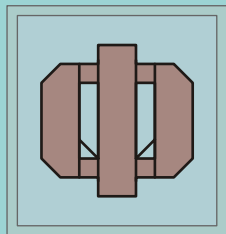

Автор: Константин Худяков
[mailto: konstantin.khudyakov@gmail.com](mailto:konstantin.khudyakov@gmail.com)

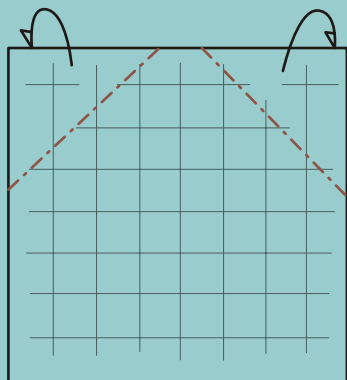

1. 8:8

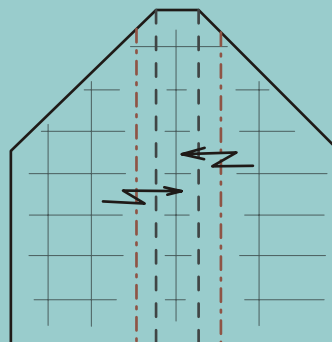

2.

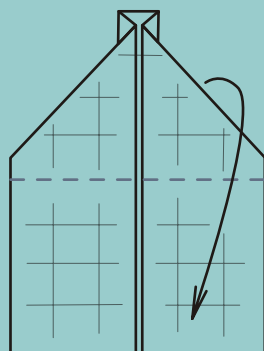

3.

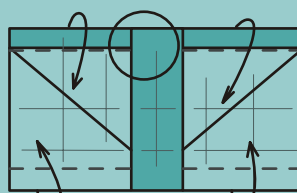

4.

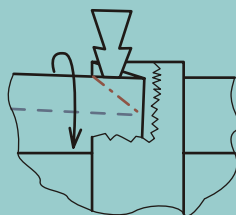

5.

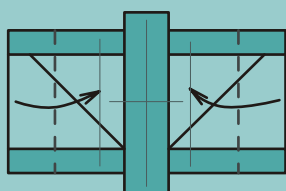

6.

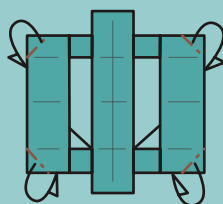

7.

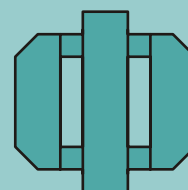

8.

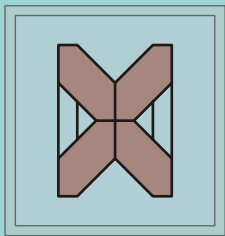

Буква "Х"

2007

Автор: Константин Худяков
[mailto: konstantin.khudyakov@gmail.com](mailto:konstantin.khudyakov@gmail.com)

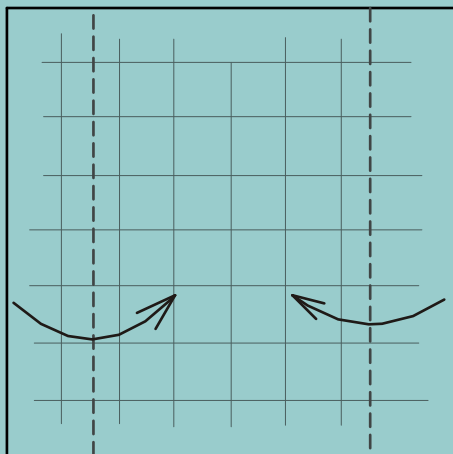

1. 8:8

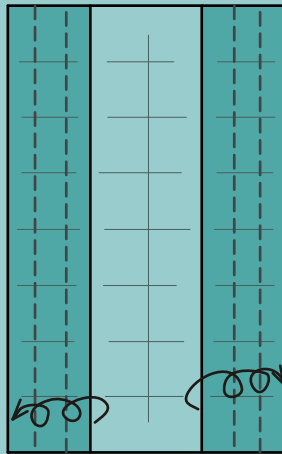

2.

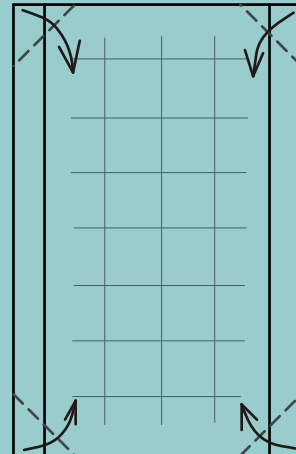

3.

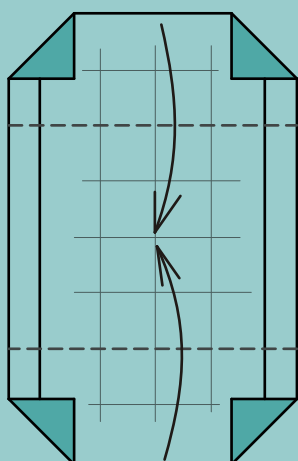

4.

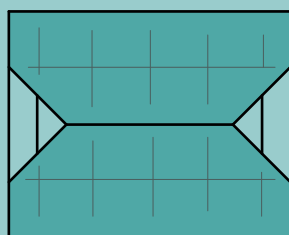

5.

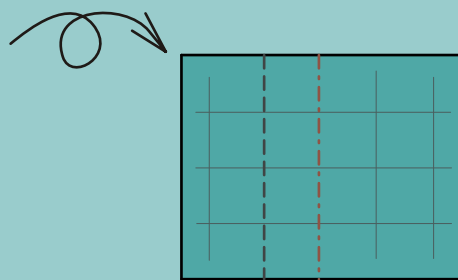

6.

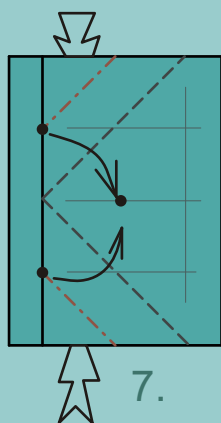

7.

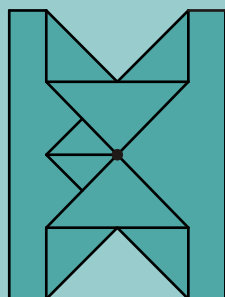

8.

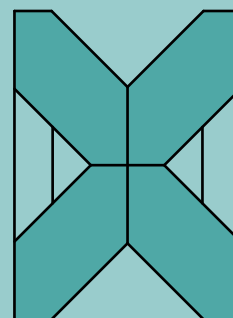

9.

Буква “Ц”

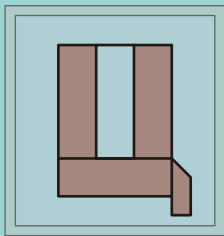

Автор: Константин Худяков
 mailto: konstantin.khudyakov@gmail.com

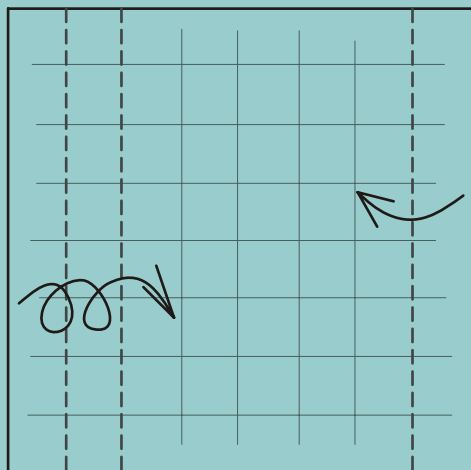

1. 8:8

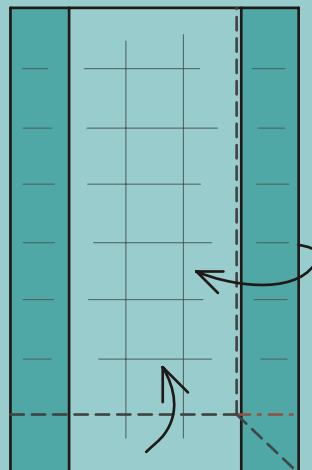

2.

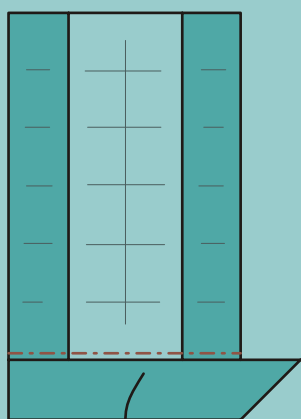

3.

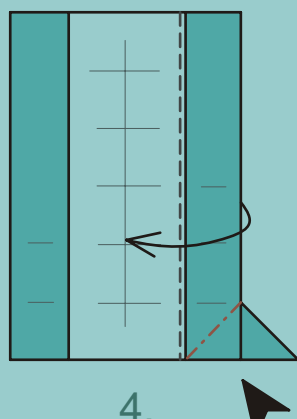

4.

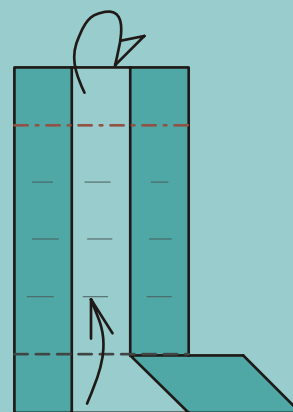

5.

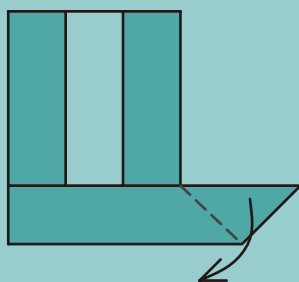

6.

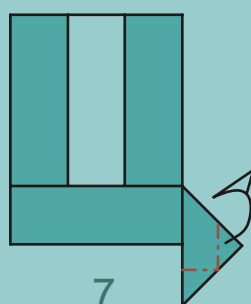

7.

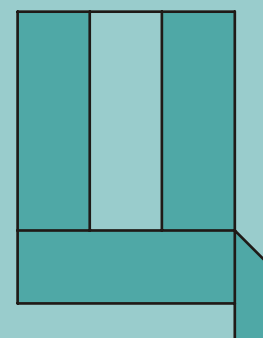

8.

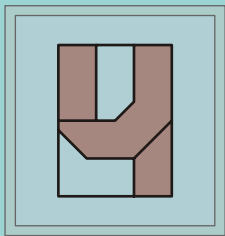

Буква "Ч"

2007

Автор: Константин Худяков
mailto:konstantin.khudyakov@gmail.com

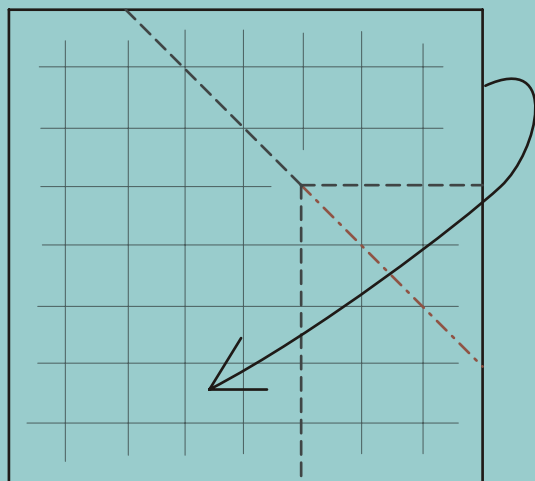

1. 8:8

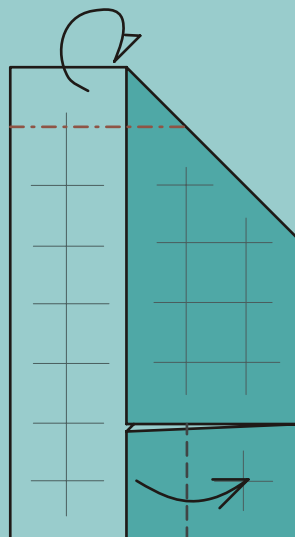

2.

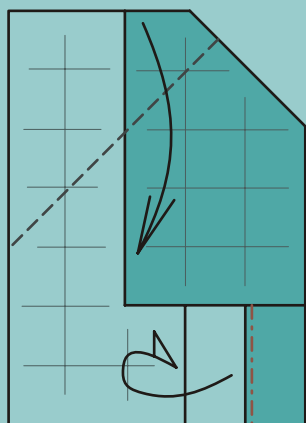

3.

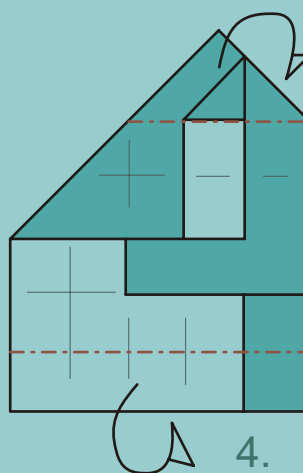

4.

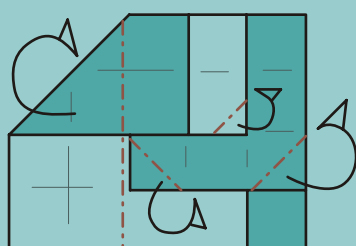

5.

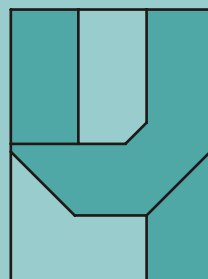

6.

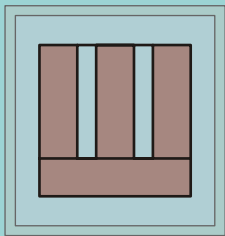

Буква “Ш”

2007

Автор: Константин Худяков
mailto: konstantin.khudyakov@gmail.com

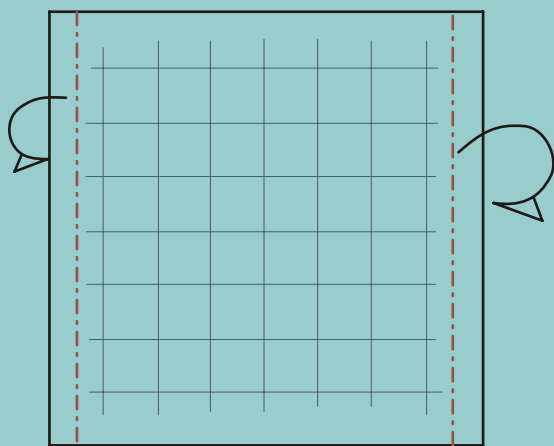

1. 8:8

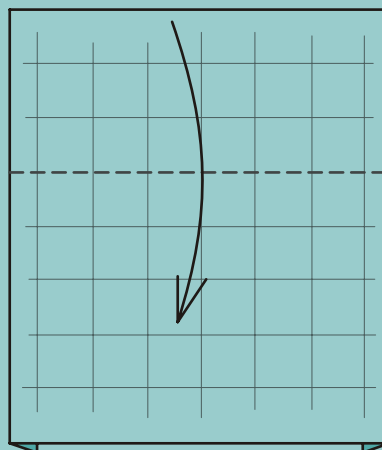

2.

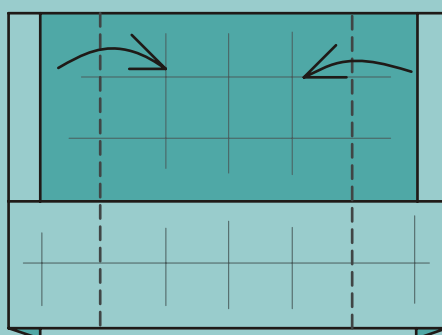

3.

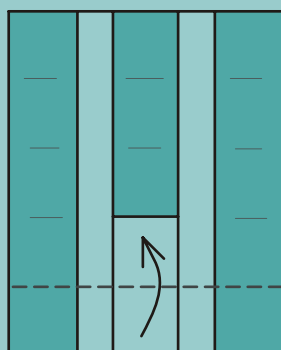

4.

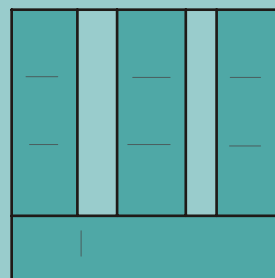

5.

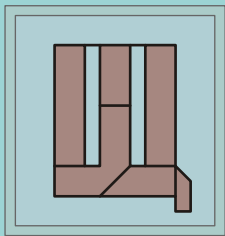

Буква “Щ”

2007

Автор: Константин Худяков
[mailto: konstantin.khudyakov@gmail.com](mailto:konstantin.khudyakov@gmail.com)

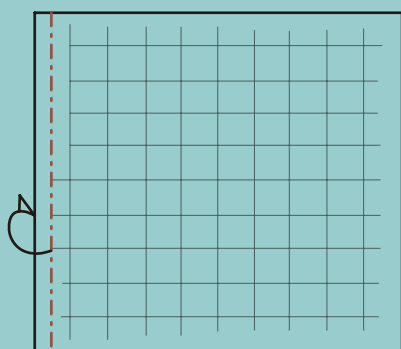

1. 10:10

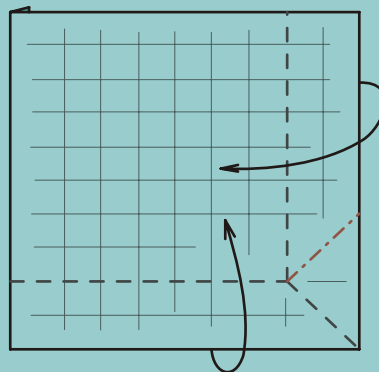

2.

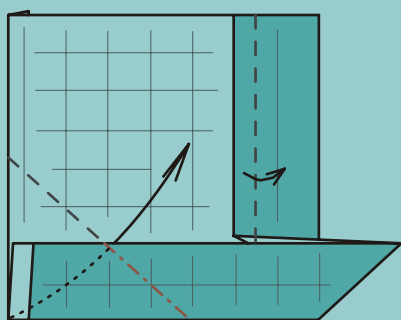

3.

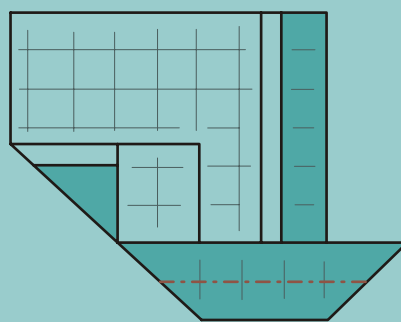

4.

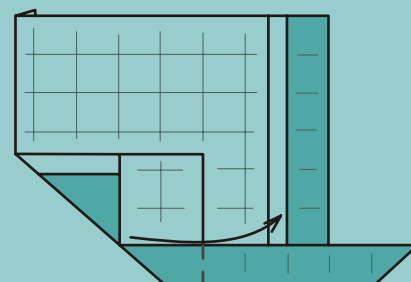

5.

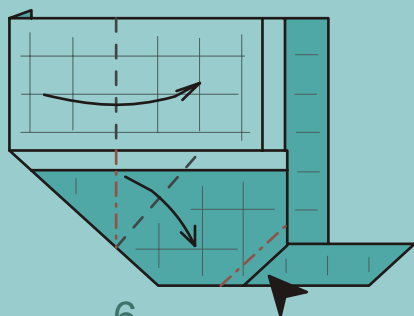

6.

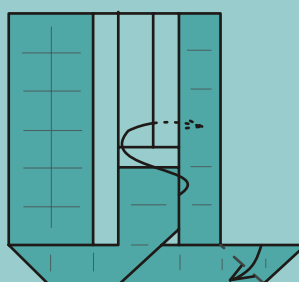

7.

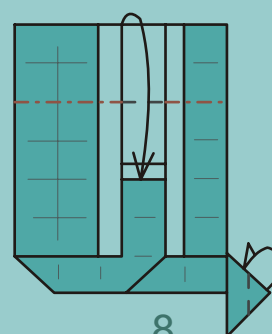

8.

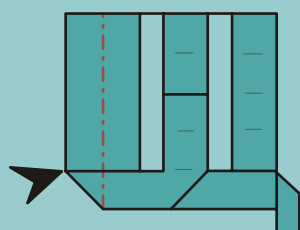

9.

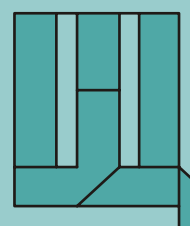

10.

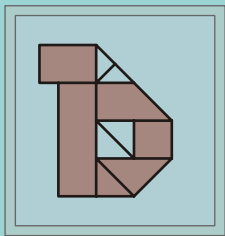

Буква “Ъ”

2007

Автор: Константин Худяков
[mailto: konstantin.khudyakov@gmail.com](mailto:konstantin.khudyakov@gmail.com)

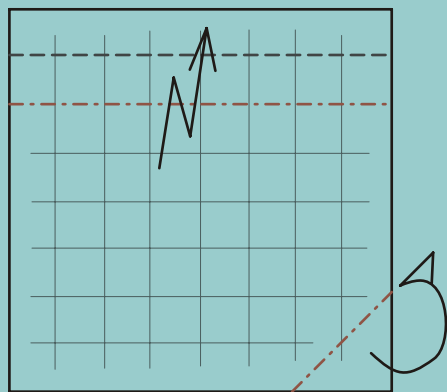

1. 8:8

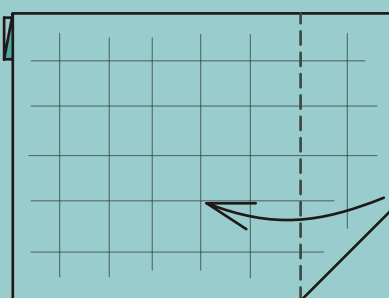

2.

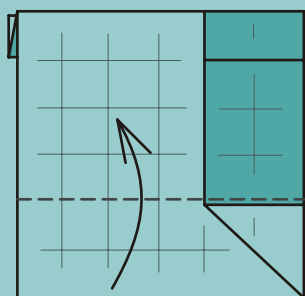

3.

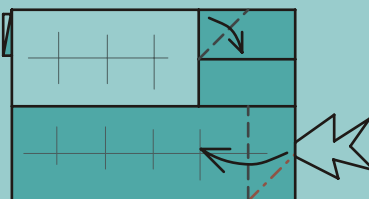

4.

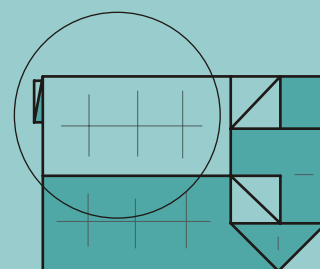

5.

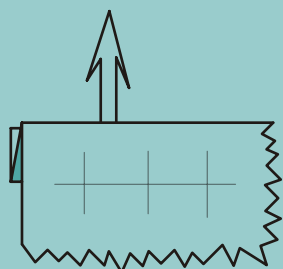

6.

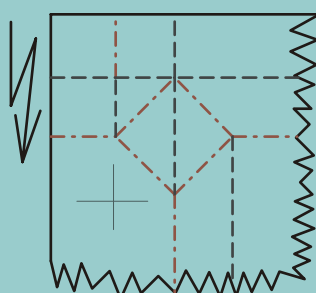

7.

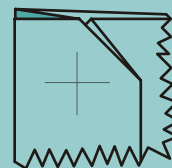

8.

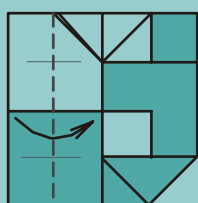

9.

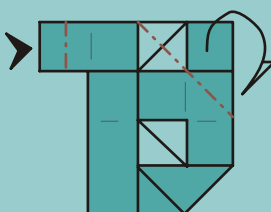

10.



11.

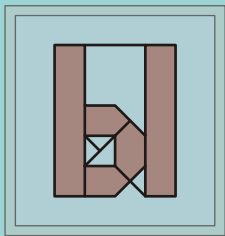

Буква "Б"

2007

Автор: Константин Худяков
mailto:konstantin.khudyakov@gmail.com

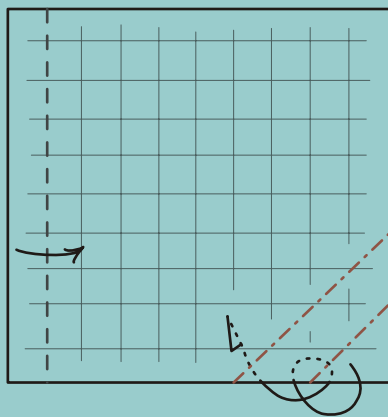

1. 10:10

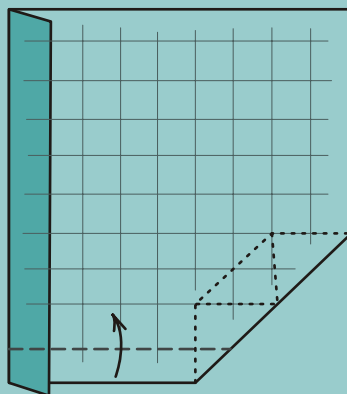

2.

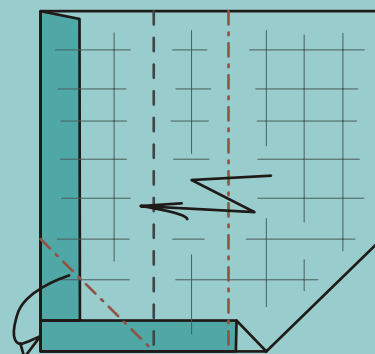

3.

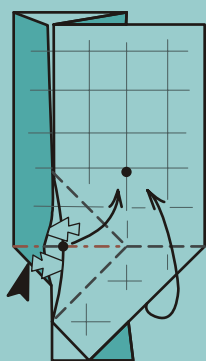

4.

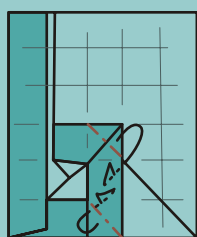

5.

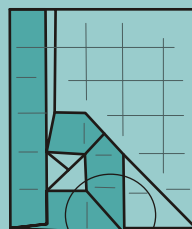

6.

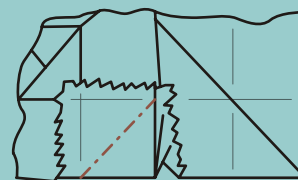

7.



8.

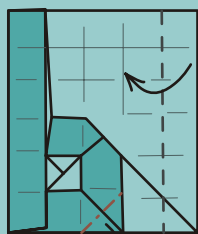

9.

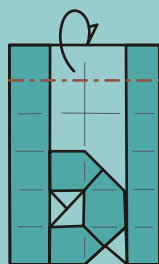

10.

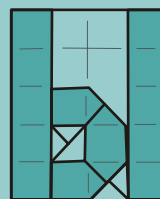

11.

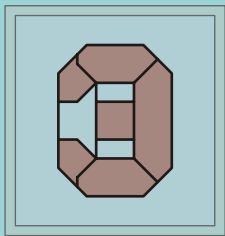

Буква “Э”

2007

Автор: Константин Худяков
mailto: konstantin.khudyakov@gmail.com

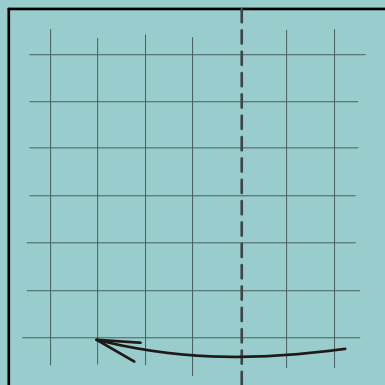

1. 8:8

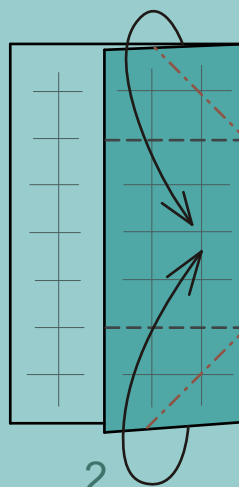

2.

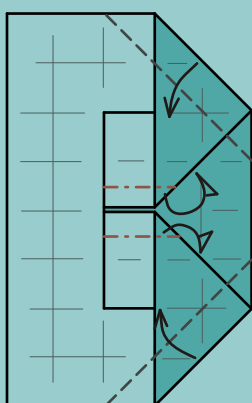

3.

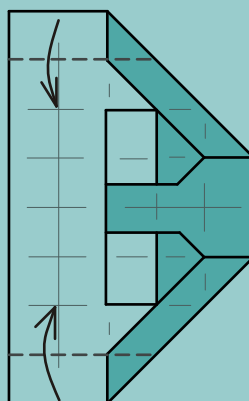

4.

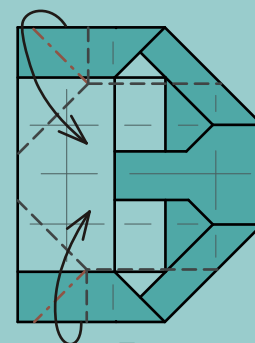

5.

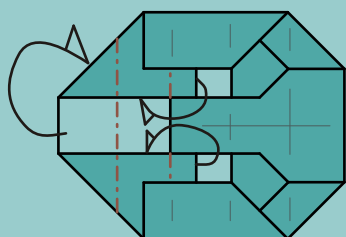

6.

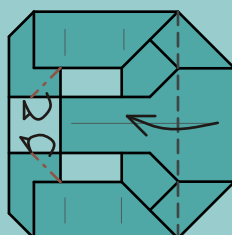

7.

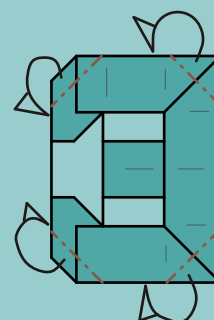

8.

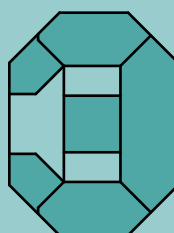

9.

Буква "Ю"

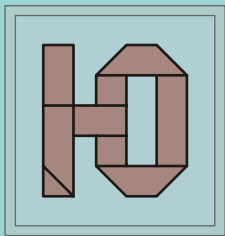

Автор: Константин Худяков
mailto: konstantin.khudyakov@gmail.com

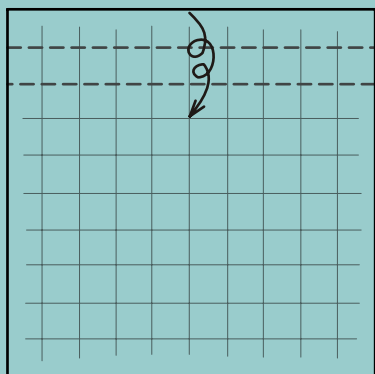

1. 10:10

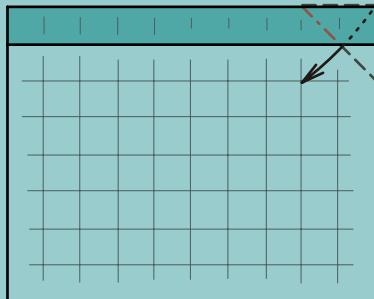

2.

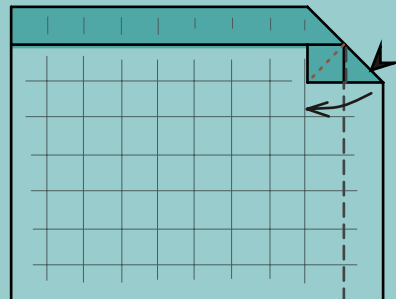

3.

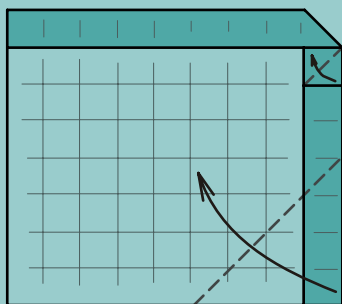

4.

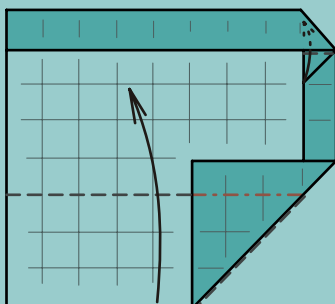

5.

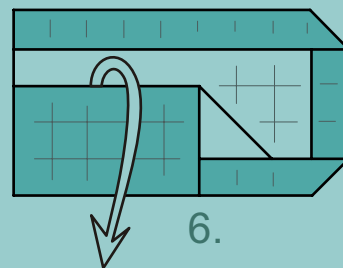

6.

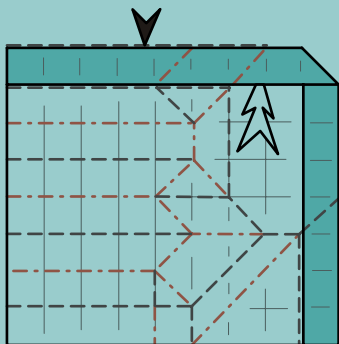

7.

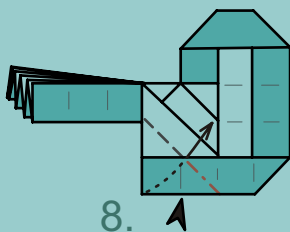

8.

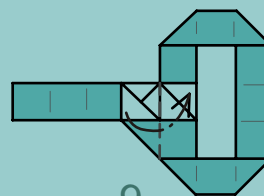

9.

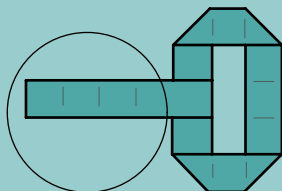

10.

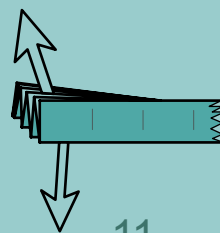

11.

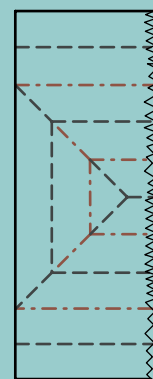

12.

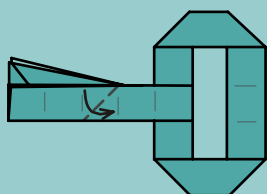

13.

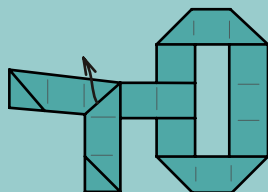

14.

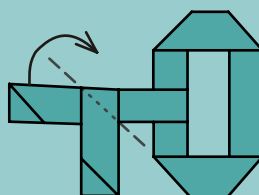

15.

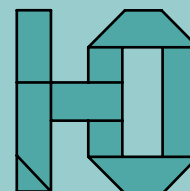

16.

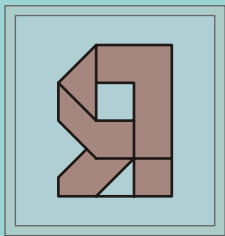

Буква “Я”

2007

Автор: Константин Худяков
mailto: konstantin.khudyakov@gmail.com

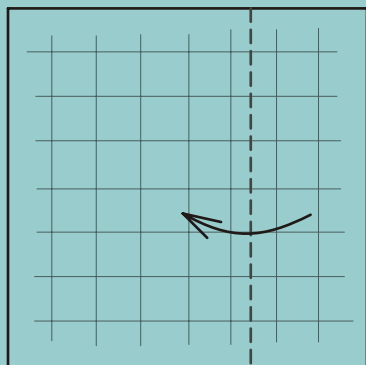

1. 8:8

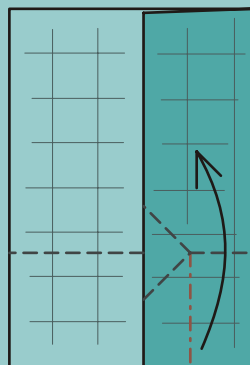

2.

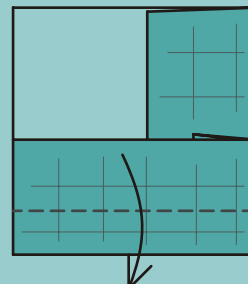

3.

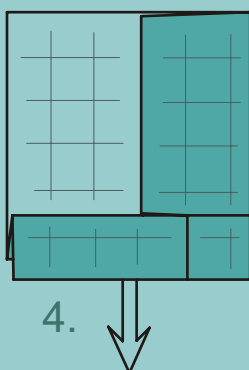

4.



5.

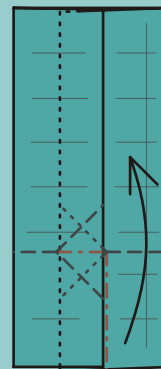

6.

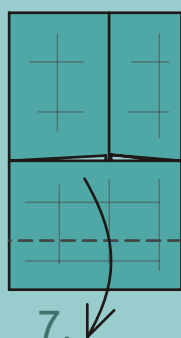

7.

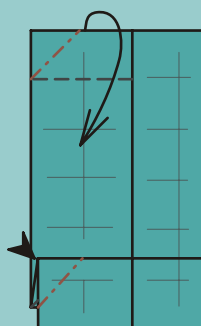

8.

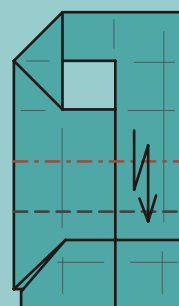

9.

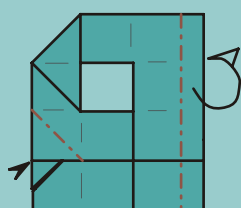

10.

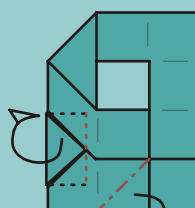

11.



12.